

# ASIA TECH RIDE ON TYPE SEEDER

(OPERATING MANUAL )

## ARP-8S(F)



**ASIA** 아세아텍  
ASIA TECHNOLOGY CO.,LTD.



### **Be sure to read the operating manual before using the machine.**

Thank you for choosing Asiatech's Riding Rice Seeder.

This operating manual show how to use the machine and what should be done or should not be done for safe operating. Read this manual throughly and carefully for correct and safe use of machine.

Keep the manual close around the machine so that you can refer to it any tine necessary.

**Please follow these**

- Do not use the machine before reading and understanding the operating manual.
- When you rent or give this machine to others, be sure to give this manual too.
- If the operating manual or other safety decals is missing or damaged, ask or order for the new manual and decals to the nearest Asiatech dealer.
- For your safe operating with this machine, be sure to read 「Chapter 1. Essential safety operating tips」 in the operating manual.
- If you have any safety concern or any comments not understood in the manual, feel free to contact to your nearest Asiatech dealer.

**Please be understood these**

- Asiatech keeps improving products. Therefore some picture or comments in the manual may not match with the actual parts on your machine. Please be understood.
- Though we proof read several time before issuing this manual, there maybe some errors or typos still. Please be understood those errors or typos could not be corrected right away.

### Safety symbols and their meanings

- If there are safety symbols as follows in the manual or decals, there maybe some danger of accident, injury or death when it was not followed. So please read and follow the directions carefully to eliminate those danger.

If the safety decals are missing or damaged, replace it with new ones right away and keep clean to make it legible.



This indicates that a condition may result in harm, fatal injury or death to you or other persons if this instruction is ignored. Follow the advice provided with the symbol of danger.



This indicates that a condition may result in harm, serious injury or death to you or other persons if this instruction is ignored. Follow the advice provided with the symbol of warning.



This indicates that a condition may result in damage to your vehicle or its equipment if this instruction is ignored. Follow the advice provided with the symbol of caution.



This indicates emphasis on notable characteristics of working procedures, and information about technology for easier operation.



This instruction is to give additional description to operator so that he/she can operate the machine more effectively and avoid doing wrong operation.

### Regarding the purpose of this machine.

- Use this machine only for transplanting the rice seedlings in the wet paddy field.  
Do not modify the machine or try to do the job which is beyond purpose of this machine. Otherwise it may cause the warranty cancellation. (Refer to warranty statement for detail)

## "Use and disposal" policy concerned with environment preservation

- We try our best to preserve the environment, always concerned about our environmental impact at each step of planning, development, production, distribution, use and disposal of products, and for our overall operations through 「environmentally friendly」 management system. We comply with international environmental regulations, environmental regulations designated by country and local authorities and other requirements with which we are in agreement, and we work towards the prevention of environmental pollution and the conservation of resources. We provide environmental education and have an awareness campaign to raise environmental awareness among all our employees and members of the supporting companies. Here we introduce 「Use and Disposa」 policy concerned with environment preservation as follows.
  1. Please read the operator's manual though for global environment protection and avoid overload job. Overload on the machine shortens the product life and increases the harmful exhaust gas which cause air pollution due to the incomplete combustion.
  2. When replacing various fluids (for engine, transmission, hydraulics, etc.) by yourself, don't dispose the used oil to anywhere not recommended. It can pollute the ground and water seriously. Please contact our local dealer to dispose it legally.
  3. Observe the operator' manual and store or dispose the waste product properly. Rust, oil, etc leaked from waste product improperly stored can pollute the ground and water. Accordingly for a waste product disposal, contact the necessarily "approved waste collection and recycling facility" to discard the used machinery legally.

# CONTENTS

---

## **CHAPTER 1: FOR THE SAFETY..... 5**

1. REGARDING THE OPERATOR..... 5
2. REGARDING THE MACHINE..... 4
3. CAUTIONS WHILE OPERATING THE MACHINE..... 4
4. CAUTIONS WHILE TRAVELING TO THE PADDY FIELD..... 4
5. CAUTIONS WHEN MOVING THE MACHINE BY A TRUCK..... 9
6. CAUTION FOR WORKING..... 10
7. CAUTIONS FOR MACHINE STORAGE..... 10
8. CAUTIONS WHEN FUELING, LUBRICATING OR REPAIRING THE MACHINE..... 10
9. CAUTIONS FOR ROAD TRAFFIC..... 12
- 10-1. DECAL MOUNTING LOCATION. 13
- 10-1. DECAL MOUNTING LOCATION. (SEEDER PART) 15
11. CAUTIONS FOR DECAL MAINTENANCE..... 17

## **CHAPTER 2: SERVICE AND WARRANTY..... 18**

1. KEEP WARRANTY CERTIFICATE IN SAFE PLACE..... 18
2. REGARDING AFTER SERVICE..... 18

## **CHAPTER 3: PRECAUTION FOR SEEDER..... 19**

1. General precautions..... 19
2. Precautions before and after operation.... 20
3. Precautions for use..... 20
4. Operating float..... 22
5. Operating pressing plate..... 22
6. Adjusting seeding interval..... 23
7. Adjusting hydraulic sensitivity..... 23
8. Adjusting seed dispenser..... 24
9. Precautions for using seeds with pesticides..... 25
10. Precautions for seeds..... 25

## **CHAPTER 4: PRECAUTION FOR FERTILIZER APPLICATOR. 26**

1. Preparation before operation..... 26
2. Correct operation and precautions during operation..... 26
3. Maintenance after operation..... 26

## **CHAPTER 4: TROUBLE SHOOTING 27**

## **CHAPTER 13: APPENDIX..... 30**

1. Major specifications..... 30
2. Major supplies and replacements (for vehicle body)..... 31
3. Seeder exterior..... 32
4. Manuring machine exterior..... 33
5. Engine exterior..... 35

# CHAPTER 1: FOR THE SAFETY

---

- The following comments are very important for your safety. Be sure to read and follow the directions.
- If the following directions are ignored, serious accident, injury or death will be occurred as well as machine break down.

## 1. REGARDING THE OPERATOR

### WARNING

- The operator should read the operating manual and safety decal carefully before starting work with the machine. If you are not the operator but owner, please ask operator to do so.
  - Drive or operate the machine carefully even if the safety decals or manual never mentioned.
- Never allow to operate the machine for any one who can not understand the manual or decals such as children.
- If you/operator are/is sick or not proper as following cases, never try to operate the machine.
  - Who can not concentrate due to overwork, drug, disease and ETC.
  - Who is drunken.
  - Who is pregnant.
  - Who did not sleep enough.
  - Who is under 18th of age.

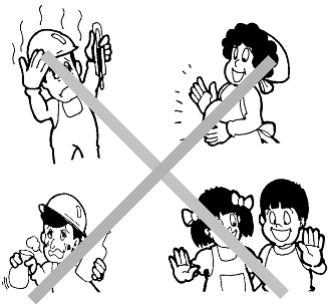

- The operator and helper should wear properly.
  - Do not wear floppy clothes especially with extra longer sleeves. It may be stuck with the moving parts, turning shaft or control levers of machine and cause a serious accident.
  - Wear an anti-slippery boots or shoes.
  - Wear safety cap.

- Do not wear scarf, hair band or don't wear the towel on your waist. Long cloth like towel may wound by the rotating shaft and lead to a serious accident.

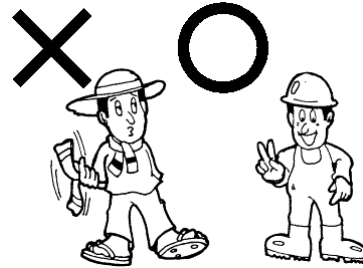

### CAUTION

- When you rent your machine to other person, be sure to ask for him to read and understand the operating manual carefully.



# CHAPTER 1: FOR THE SAFETY

## 2. REGARDING THE MACHINE

### CAUTION

- Be sure to check the machine before starting work. Repair it if necessary.

Working with the malfunctioned machine will cause an accident or machine break down.

- Replace the damaged or missing parts.
- Daily checking items such as brake, steering handles and other safety parts should be check or replaced as necessary.
- Bolts and nuts should be checked periodically and re-torqued if necessary.
- Check daily if any wire code is peeled and contacted with other parts. Check if the connectors or terminals of wire code is loose. Fix the wire code if necessary.

### CAUTION

- Clean the machine before storage. Dust or fuel stuck around the battery, wire code, silencer or engine may cause a fire on the machine.
- Do not modify the machine. It may deteriorate the safetiness of machine and cause to an injury or death. It also deteriorate the machine performance or life time.

## 3. CAUTIONS WHILE OPERATING THE MACHINE

### CAUTION

- Before starting the engine, be sure to sit on the operator's seat and check if the parking brake applied, main shift lever is in 「Planting」, planting lever is in neutral and speed set lever is in 「Stop」 position.

Otherwise, the seedling planter may abruptly move to cause an accident of falling off or crash.

- The possibility of accident by abrupt movement of machine is even higher when the machine is on the road or on the pavement rather than in the paddy field.

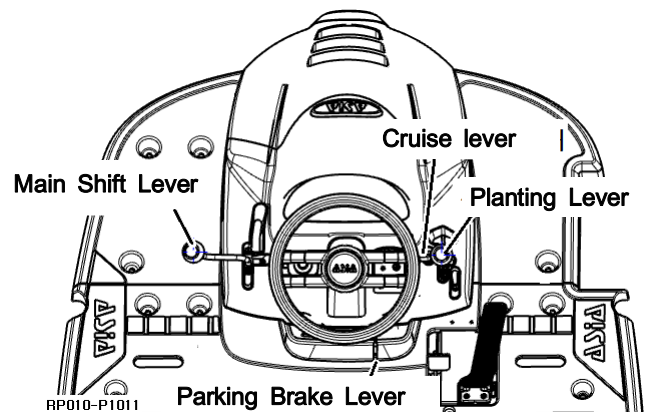

### WARNING

- The engine exhaust gas is very harmful to the human body. Be sure to ventilate the garage or warehouse well when running the engine inside of those buildings.
- Running engine in the building without good ventilation will cause a serious injury or death due to the poisoning exhaust gas from the engine.
- Always run the engine outside with good air circulation.





- Before moving the rice seeder, check if any control levers are located for moving forward.
  - Side maker and line marker should be stowed and the seedling mat plate should be in its center to avoid collision with obstacles.
  - Raise the planting section and place the hydraulic lock lever in its 「Lock」 position. Otherwise, the planting section may move down and cause an accident or machine break down.

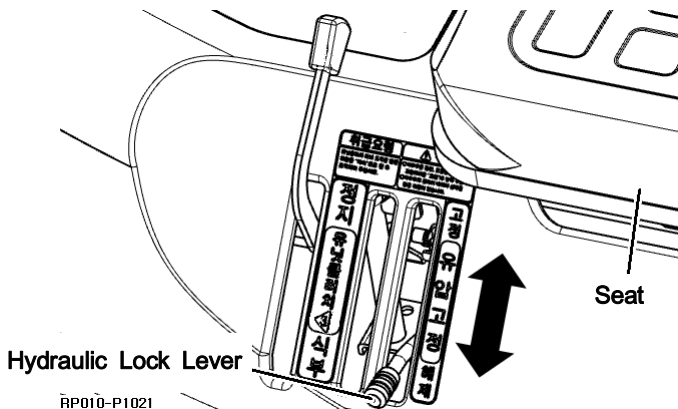

- See around the machine before running the engine or moving the machine for safety.
  - Give signal to helpers or bystanders around the machine when running the engine or starting to move to avoid accident.
  - Before moving the machine, be sure to check if any bystander or children near the machine. You may not find the bystander or children in the blind spot near the machine.
  - To stop machine, be sure to place the speed set lever in its 「Stop」 position and main shift lever in its 「Seedling mat add」 position. Apply the parking brake after stopping the machine.

**! WARNING**

- Do not drive the rice seeder on the public road.
  - To move machine long distance, use the truck.
  - Moving long distance driving rice seeder may cause a damage to the driving gears in the transmission.

**! WARNING**

- Drive slowly to avoid collision with the obstacles around the machine. Be careful especially for the seedling mat loading stand to avoid collision.
  - Don't commit the careless driving such as neglect watching forward or hands-off steering wheel. Otherwise, it may cause a serious injury or death. Novice driver should drive the machine even slower.
- Never start, stop or turn violently. It may lead to the rollover.
  - Reduce speed on the curved road and turn slowly.
- Only one driver(or operator) can be seated on the machine. Do not let anybody load on the machine.
  - Do not load anything on the extra seedling mat loading stand.

**4. CAUTIONS WHILE TRAVELING TO THE PADDY FIELD**

**! WARNING**

- Extra careful to drive along the road which has steep sloping shoulder.
  - Consider that the road shoulder may collapse.
  - If you are not sure if the road is safe because of the over grown weeds, Stop the machine and engine, apply the parking brake to get off the machine and inspect the road carefully.
  - Do not drive the machine close to the road shoulder too much to avoid the other machine on the same road. Stop the machine at first and let the other machine go ahead.

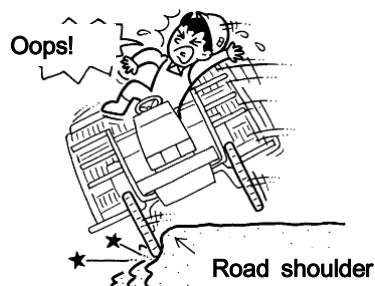

**! WARNING**

- Drive extra carefully while traveling along the sloping road.
  - Never start or stop the machine violently. Otherwise, it may cause a rollover.
  - Be sure to reduce the speed to drive along the sloping road.
  - Do not change the shift levers while traveling along the sloping road. The machine may free wheeling down the road and cause a serious accident.

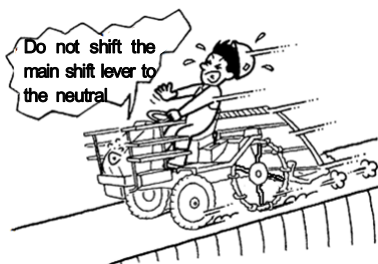

- Apply the brake firmly to shift the main shift lever on the slope of the road. Never shift it to the 「Neutral」, or 「Seedling mat add」. Otherwise it may cause a serious accident.
- Apply brake quickly and firmly to stop machine on the sloping road.
- Do not drive the machine transverse direction to the sloping road. It may roll over to the side.
- Do not operate the steering wheel too much on the slope. The drive train to the rear wheel on the same side as steered will be disconnected and lead to rollover of machine.
- To enter the paddy field through the steep slope, drive backward up the slope, drive forward down the slope with lowest speed. If machine is driven forward-up the steep slope, the front wheels can get off the ground and lead to rollover.

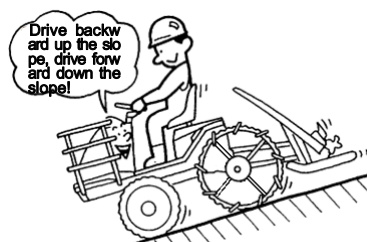

**! WARNING**

- When going over or across the foot path or ditch, lower down the planting section and drive slowly with differential pedal depressed. Drive the machine vertical to the foot path or ditch. When the rear wheels are on top of the foot path, raise up the planting section before going down from the foot path.

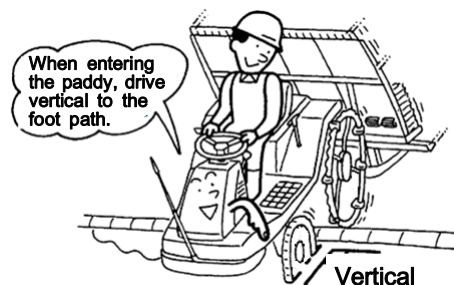

- Use the loading boards to go up/down the foot path with steep slope, or to go across the ditch.

Recommended dimension of loading board.

Length	3.5 times longer than cargo bed floor height
Width	Width
Strength	Should sustain 500kg or more with one board
Surface	Make the board surface rough so that it may not slippery

- Don't forget to depress the differential pedal to drive along the loading boards.
- When placing the loading boards, make them vertical to the foot path or ditch and align them horizontal to the wheels of machine.
- When leaving the machine, park it on the leveled ground, place the main shift lever to 「Planting」, apply the parking brake and stop the engine.
  - If you have to leave the machine on the slope, place the main shift lever 「Forward」 or 「Reverse」, lower the planting section down on the ground, apply the parking brake and place the chocks under the wheels. Failure to follow these directions may lead to the accident by the self-moving machine.

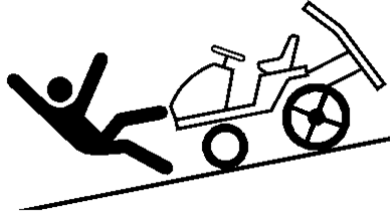

- Be sure to remove the key when leaving machine.

## 5. CAUTIONS WHEN MOVING THE MACHINE BY A TRUCK

### WARNING

- Choose the leveled and wide place for loading/ unloading the machine on/from the truck.
  - Stop the truck engine, place the shift lever in 「P」 or 「1」 or 「R」 position and apply the parking brake.
- Move the rice seeder reverse to load it on the truck, forward to unload it. Moving forward the machine to load it on the truck may cause the rollover as the front of the machine is lighter than rear of the machine.
  - Align the boards well so that the wheels of machine can moving along the center line of boards.

### CAUTION

- Ask for the helper to guide when loading or unloading the machine to or from the truck.
  - The helper should not stay right in front of the machine or behind the machine.

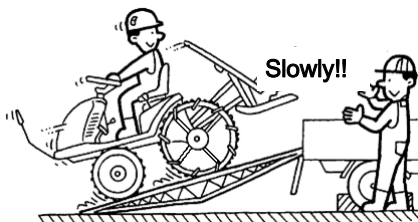

### WARNING

- Never shift the shift lever while the machine on the boards.
  - Try shifting on the boards may lead to

the serious accident as the machine can free wheeling down the sloping boards.

- Apply the brake firmly to shift the main shift lever on the sloping boards to avoid danger. Never shift it to the 「Neutral」, or 「Seedling mat add」 or 「Travel」. Otherwise it may cause a serious accident.
- Apply brake quickly and firmly to stop machine on the sloping boards to avoid danger.
- Apply brake quickly and firmly when the engine is stopped and re-start the engine.

### ■ Do not turn the steering wheel to much on the loading boards.

- The side clutch to the rear wheel on the same side as steered will be disconnected and lead to rollover of machine.
- After loading the machine on the truck, place the main shift lever in 「Forward」 or 「Reverse」 position and apply the parking brake. Tie down the machine with rope or belt with strength. Otherwise, the machine may fall from the truck.
- Remove any objects on the seedling mat stand. Otherwise it may fall down and lead to an accident.

## 6. CAUTION FOR WORKING

### WARNING

- When adding the seedling mat on the seedling plate, reduce the engine speed with speed adjusting lever and place the main shift lever to 「Seedling mat add」 position.
- Be careful not to touch the hot surface, moving parts or turning shaft of the machine to avoid burning or wounding accident.



### WARNING

- To remove any debris or seedling stuck from the planting section, stop the engine and make sure every moving or rotating parts are entirely stopped to avoid wounding accident.

### CAUTION

- Watch out for the bystanders or obstacles when turning at the end of the paddy.
- While working in the paddy field, do not anybody come near the machine or never allow them to stay in the same paddy in which the machine working. Especially watch out for the children.
- Do not load any object or person as a counter weight on the machine.
- Do not work in the night time. Over night working with poor visibility may lead to an accident.

## 7. CAUTIONS FOR MACHINE STORAGE

### CAUTION

- For long term storage of the machine, park the machine on the leveled ground, place the main shift lever to 「Seedling mat add」 position, lower the planting section down to the ground and apply the parking brake.

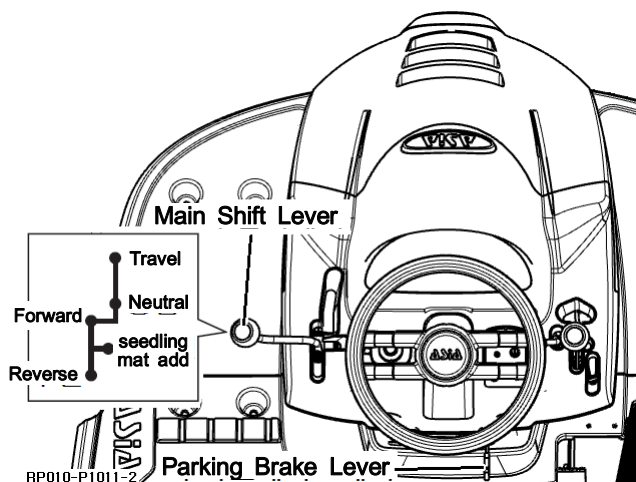

- Remove the battery from the machine.
- Drain the fuel from the fuel tank or carburetter for long term storage.
- Remove any flammables around the machine.

### WARNING

- To wrap the machine with cover, wait until the hot parts of machine cools down. Otherwise, it may lead to the fire on the machine.

## 8. CAUTIONS WHEN FUELING, LUBRICATING OR REPAIRING THE MACHINE

- For checking, fueling or repairing, park the machine on the leveled and safe ground away from the bypassing vehicle and stop the engine.
  - Place the hydraulic lock lever to 「Lock」 position and apply the parking brake.
  - Place the main shift lever to 「Seedling mat add」 position.

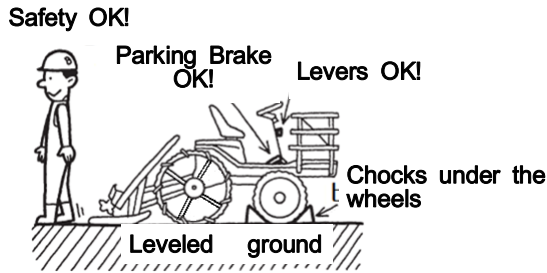

- When checking the planting section with planting section raised, place the hydraulic lock lever in 「Lock」 position and support the planting section with safety stand.
- Be careful not to be hurt by the sharp tips of planting pins.

### CAUTION

- Do not allow any bystander or children come near the machine while checking, fueling or repairing the machine. Especially watch out for the children as they may be in the blind spot behind the machine or touching the machine.
- After checking, fueling or repairing the machine, put any covers back to normal. Operating machine without those covers may lead to an accident.



### DANGER

- Never use the cigarette lighter as a flash light during re-fueling.
- After re-fueling, fasten the fuel filler cap securely and wipe off the fuel around fuel filler or fuel tank to avoid any possible fire.



### WARNING

- Never run the engine with the air cleaner cap open. It may lead to catch fire on the machine by the reverse flame from the intake manifold of engine.

### CAUTION

- Wait until the hot parts of the engine cools down before checking, re-fueling or repairing the machine. Otherwise, it may lead to skin burn.
- Check for the exhaust pipe and its connector.
  - Before working, check for the crack or rust on the exhaust pipe or its connector. Remove any dust or debris from the exhaust pipe or connector to avoid the possible fire on the machine.
- The rubber made parts such as fuel hose, radiator hose or oil drain hose should be replaced with new every 2 years. Electrical wire harness should be check every 50 hours of work or every year whichever come first.
  - The rubber made parts intend to be deteriorated as time goes by. So neglecting to replace can lead to machine break down or accident.

**! WARNING**

- To check or replace the battery, follow the direction below.
- When disconnect the battery cables, disconnect the 「-」 cable first. When connect the cables, connect the 「+」 cable first. Otherwise, it may cause an electrical short or fire on the machine.
- Be careful not to short circuit on the battery terminals.



- Do not use the battery other than starting engine.
- To recharge the dead battery, remove it from the machine. Do not recharge the battery in the enclosed room.
- When replacing the battery with new one, use the proper battery as described in this manual. Otherwise, it may cause a short circuit or fire on the machine.

**! CAUTION**

- **Check for the wheels and axles.**
- Check for the looseness on the wheel attaching area. Retorque any loosen bolts or nuts. Otherwise, it may lead to an accident.
- Check for any crack or damage on the wheels or axles. It may cause an accident or machine break down.

9. CAUTIONS FOR ROAD TRAFFIC

**! WARNING**

- If the machine is out of order on the public road, place the warning sign behind the machine.
- If the machine is out of order during traveling on the public road, place the warning sign 100~200M behind the machine in accordance with local traffic law. Otherwise, it may lead to a car accident.

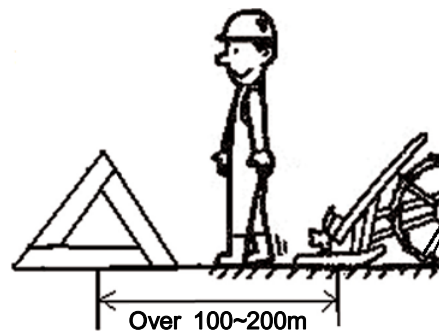

## 10-1. DECAL MOUNTING LOCATION

- This picture shows the locations of safety decal for your safety.
- Keep the safety decals clean and neat. If those are lost or damaged, replace those with new ones.

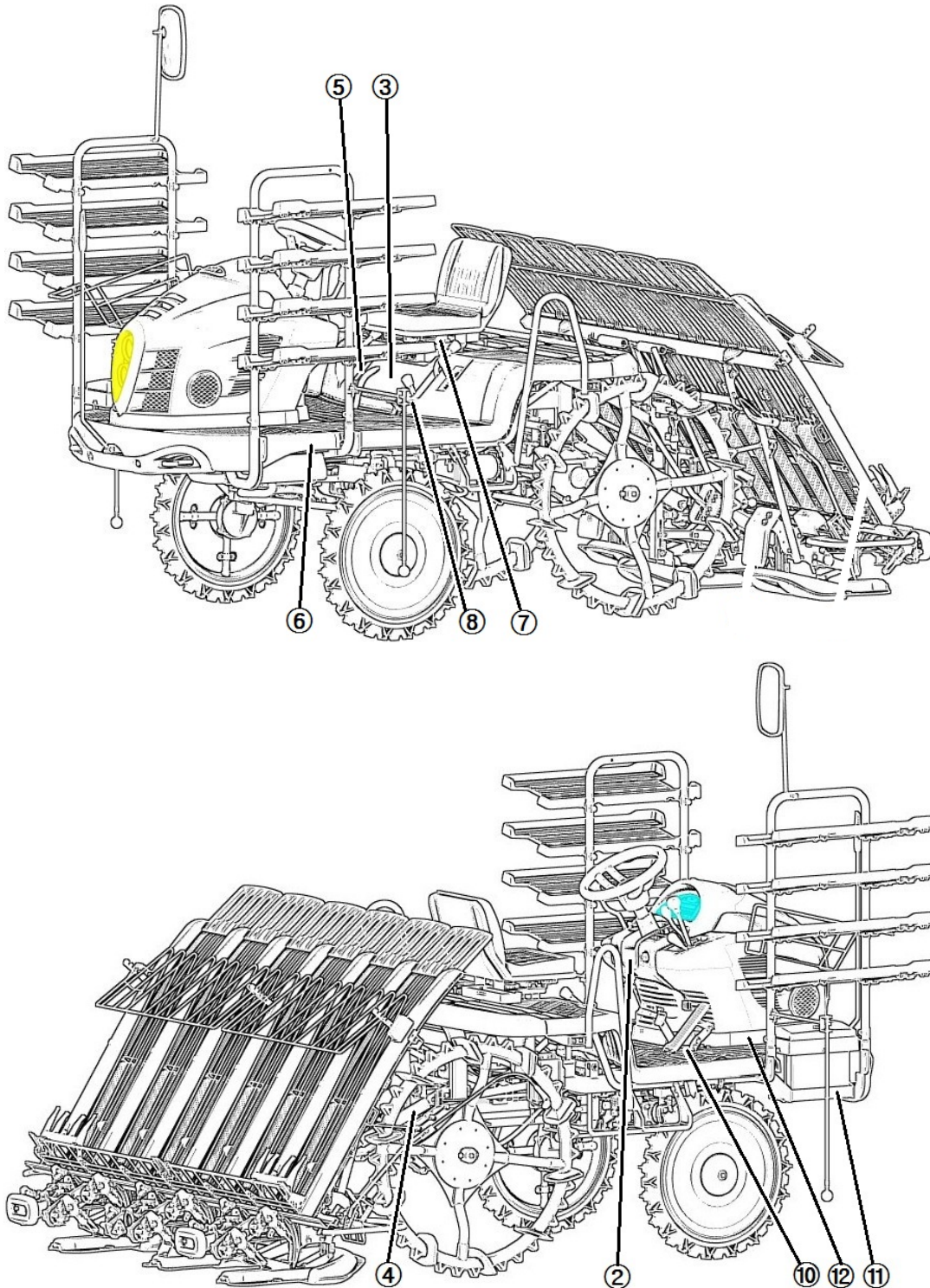

② RP012-H2111 CAUTION DECAL(Cover)



③ RP012-H2011 GENERAL SAFETY DECAL

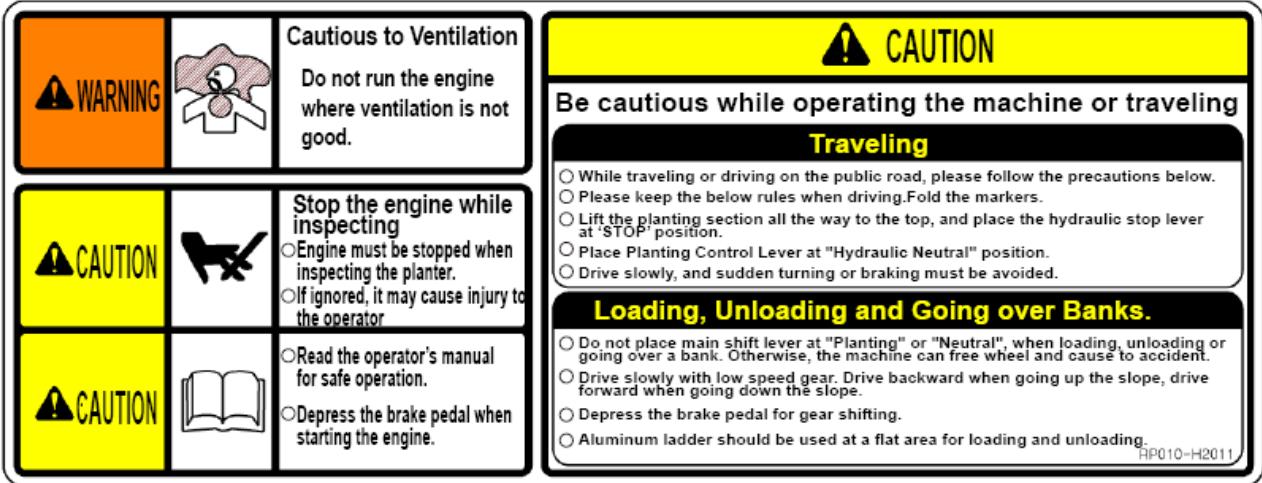

④ RP012-H2021 CAUTION DECAL(Rotation)



⑤ RP012-H1011 Hydraulic lock unit clutch 3 decal

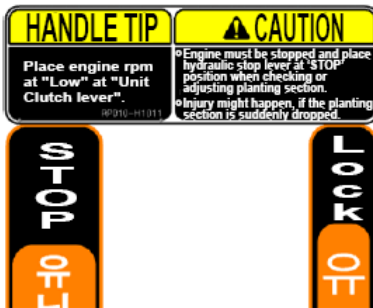

⑩ RP012-H2041 CAUTION DECAL(Accel, draft)

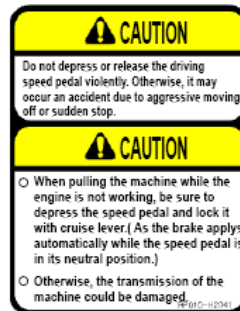

⑥ RP012-H2101 CAUTION DECAL(Muffler)



⑦ RP012-H2061 DANGER DECAL(Fueling)



⑪ RP012-H1181 CAUTION DECAL(Battery checking)

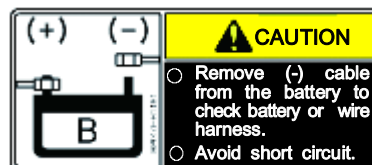

⑧ RP012-H1191 Differential. lock decal



⑫ RP012-H2051 CAUTION DECAL(Fan)





### 10-1. DECAL MOUNTING LOCATION(SEEDER PART.)

- This picture shows the locations of safety decal for your safety.
- Keep the safety decals clean and neat. If those are lost or damaged, replace those with new ones.

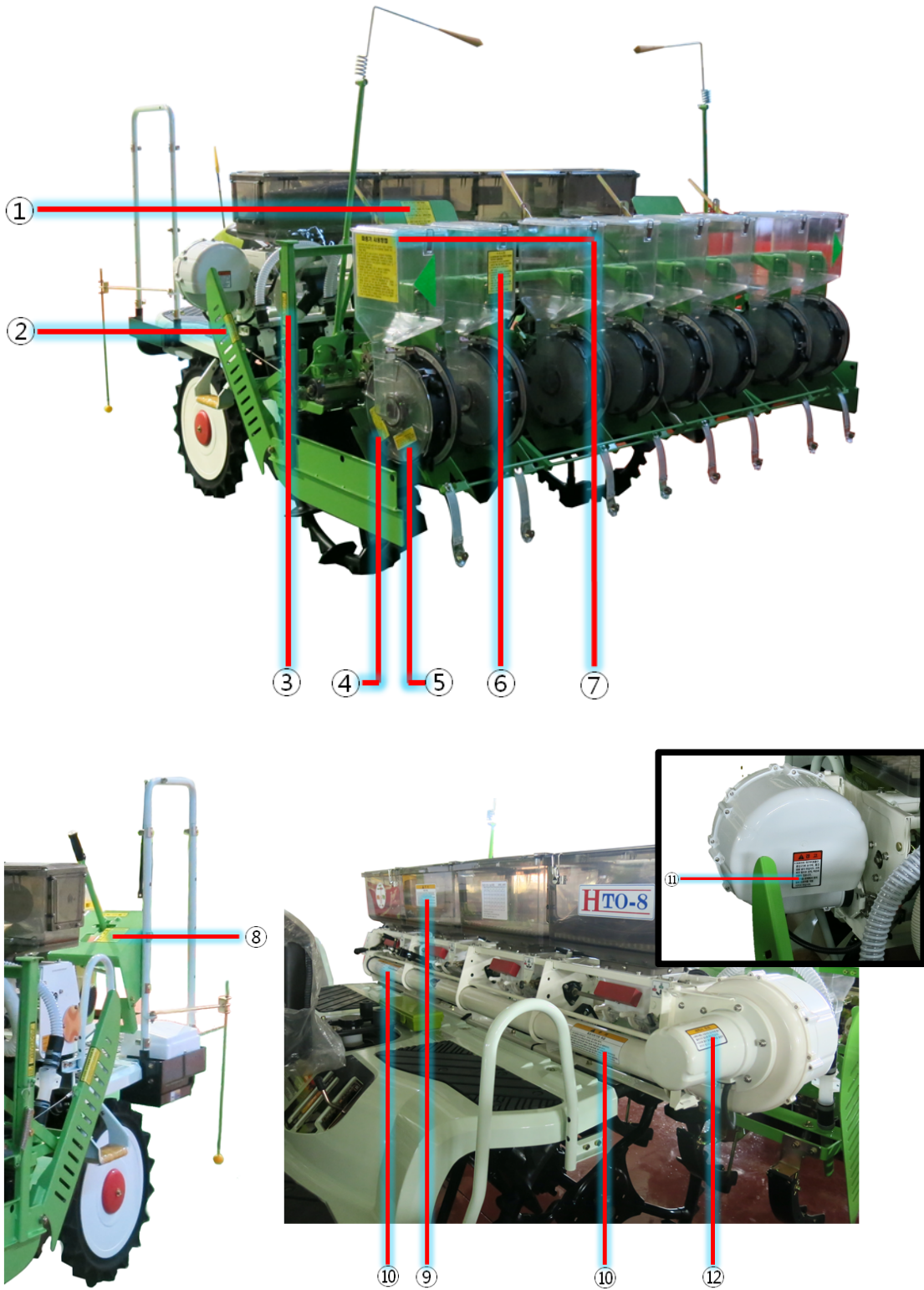

# CHAPTER 1: FOR THE SAFETY

## ① Seed care tips

- Please completely dry the seeds and then sow.**  
(If the seeds have moistures, they will be mixed each other and it will be difficult to get through the seed pipe and eventually it may cause the missing plants.)
- Please don't sow in a rainy day**  
(If there are some moistures on the outlet of seeder, seeds can be stuck together and it may cause the missing plants.)
- When you work, Cap of seed bucket should be opened.**  
(Because moistures can be generated in the seed bucket and seeds are stuck together and it can be difficult to be dropped and it may cause the missing plants.)
- Please check if there are seeds inside the machine.**

## ② When planting near levees

▶ **In case that you sow by the last ridge between rice paddies**  
In case that both side line markers are raised up, please remove the wire from the loop and lower the water soil plate and then do your sowing works.

## ③ Stand, Use the stand

**Stand**  
Just hang the spring.

When you store it with lowered seeding section, please hold it with stand

## ④ Seeds quantity adjustment plate

**Seed quantity adjustment plate**  
Turn the left cover to arrow direction and then remove the seed quantity adjustment plate. After that, match the arrow mark on the adjustment plate to the number on the seeder body case.

Ⓢ Default setting value is no.2.  
the bigger number written on the body means the more seeds to come out. In the meantime smaller number means less seeds to come out.

## ⑤ Place of seed taken off

▶ **Place of seed taken off**

- Remove the toggle clamp and then turn the left cover to arrow open direction to take it off.
- When assembling, you fit the connecting pipe onto seed bucket and then turn the left side cover to arrow close direction and fit the toggle clamp and then use it.

## ⑥ Caution

**CAUTION**

- Please remove the awns and the other foreign substances stuck on rice seeds and then sow.
- In order to make the rice seed sprout less than 2mm, please bud it little bit and then sow.
- Please dry the rice seeds without water and then sow.
- Use the agricultural chemicals diluted with water. (Do not use undiluted one)
- After washing the seeder, please fully dry and then work the machine as it may be happened that the seeds are stuck on the exhaust outlet and it may cause the missing plants.
- Please do not sow when it rains.

**ASIA 아세아텍**

## ⑧ Rice seed suppress lever

**Rice seed suppress lever**

Ⓢ In case of watering paddy fields, you can put the lever into "lit" position. If the fields don't have water, you can put it into "lower" position.

Ⓢ Caution : If you suppress the rice seeds in the watering paddy spot, the seeds will be sowed deeply and the germination rate may be dropped or rice seeds can be covered in one side.

Fall ↑  
Lift ↓

## ⑦ How to use ASIA PADDY SEEDER

**How to use ASIA PADDY SEEDER**

- Spacing in the row is adjustable with number of plants as 45, 50, 60, 70 and 80. You can adjust number of plants with adjusting lever which is fitted on ARP-60. (Ride on Rice transplanter.)
- Please completely dry the rice seeds and then put them into the seed bucket.
- Please start the engine of rice transplanter and foot the sub-shift lever and then make the paddy seeder idling several times with low speeds. After that, Check the rice seeds are coming out with suitable quantities.
- When adjusting seeds quantities, please adjust the negative plate of disc. (the bigger number written on the body means the more seeds to come out)
- "Sowing speed"-Sowing speed should be fitted with the speed of rice transplanter.
- Depending on the condition of paddy fields, rice seed plate can be adjustable with suppress lever around the steering wheel. In case of watering paddy fields, you can put the lever into "lit" position. If the fields don't have water, you can put it into "lower" position.
- When you try to take off the leftover rice seeds, you first shut off the power and then remove the toggle clamp and then turn the left side cover. After that, operate the paddy seeder and clean up the awns and foreign substances. And then assemble it with matching same number on the disc plate.

**ASIA 아세아텍**

## ⑨ Treatment of fertilizer

**CAUTION**

**Treatment of fertilizer**

In case of use of the inappropriate fertilizer, it will cause the blockage of the fertilizer or non-uniform of fertilizer quantity.

- Appropriate fertilizer should be selected and use the fertilizer without lump which is just opened. (Appropriate fertilizer has 2mm to 5mm of its particle. If it's too tiny or huge, it may cause the irregular ejection quantity.)
- In case of use of wet fertilizer, it can be very sticky and it causes operation troubles, malfunctions and machine broken. Please make sure that the fertilizer is fully dried.
- Please be cautious not water to soak into the fertilizer and also to flow into hopper when you work on the rainy day.
- After use of the fertilizer, please store the leftover in a dried place without moisture.

## ⑩ Treatment of side manuring machine

**CAUTION**

**Treatment of side manuring machine**

- Please do not wash it with high pressure. It may cause malfunctions.
- In case of washing manuring roll case, please make sure that you completely dry it first and then use it.
- When taking breaks during work, please lift up the seeding part, in order to avoid that dirt obstruct the outlet.
- When you finish daily works, please remove the leftover fertilizers from the roll case and hopper.
- Do not start quickly. Otherwise the rice plants are not growing suitably due to without manuring at the early start. (within 1m)
- If you stop suddenly, the fertilizer can be intensively spreaded particularly in one spot. That is why you must stop slowly.

## ⑪ Warning of blower ⑫ Washing the machine

**WARNING**

- Please do not insert your fingers or anything inside inlet of blower. As it rotates very fast, it may cause any injury or damage.
- Please do not operate the blower when you separate the side manuring machine from the body.

**Caution when washing the machine**

When washing the machine, please make sure that there are no water inflow into inlet of blower. If water flows into the motor, it may cause operation troubles.

## 11. CAUTIONS FOR DECAL MAINTENANCE

- Keep the decals clean and intact. If any decal is dirty, wash it with soap and dry with a soft cloth.
- Do not spray high-pressure water directly onto the decal. The decal may fall off the machine.
- If a decal is damaged or lost, contact your local dealer immediately to install a new decal.

# CHAPTER 2: SERVICE AND WARRANTY

## 1. KEEP WARRANTY CERTIFICATE IN SAFE PLACE



### WARNING

- Do not modify the machine. If it is damaged by unapproved modification and misuse against description of manual, it will not be covered under warranty.

## 2. REGARDING AFTER SERVICE

If you have a problem on your machine, refer to 「Chapter 12 Troubleshootings」 of page 100 to check by yourself. Or contact immediately to authorized dealer nearby.

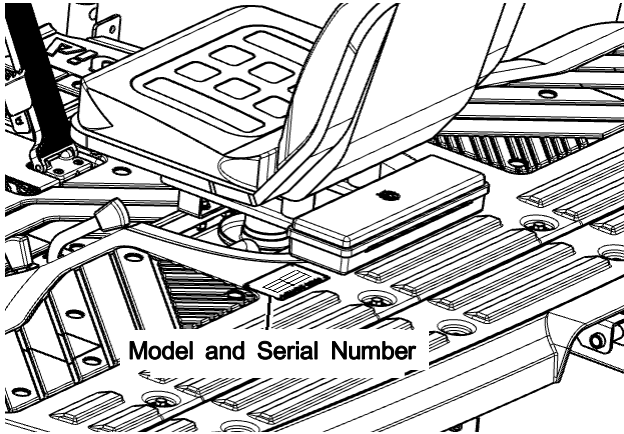

Model and Serial Number

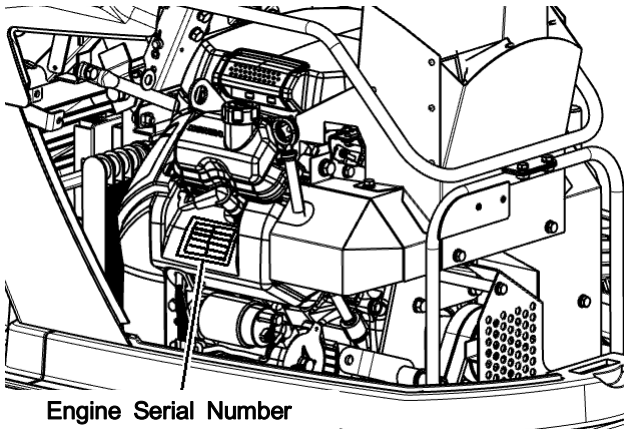

Engine Serial Number

《Be prepare for the following question before calling》

- Model and serial number (In case of engine failure, engine serial number)
- Working conditions (Travel speed· working description)
- Run hour of machine (After working□□hours)
- Describe the problem as detail as possible

《Supply period of service parts》

The service parts of this machine will be available until 9 years after stop production of the model.

Even if the parts are still available, some parts need more lead time than the other. Please consult your dealer for the lead time beforehand.

Service part will not be available after 9 years from the day of stop producing, some parts, however, might be still available, Please consult part staff of your dealer any way.

《Genuine parts and oils》

The genuine parts and oils are passed severe durability and performance test. Please use our genuine parts for your safety.

Use our genuine part only!

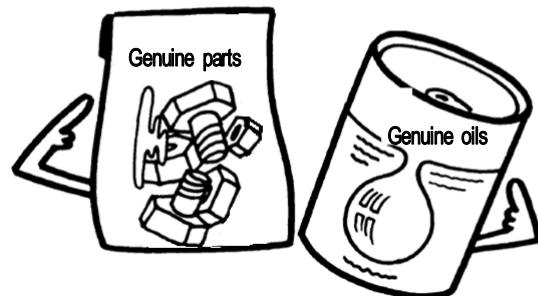

# CHAPTER 3: PRECAUTION FOR SEEDER

---

## 1. General precautions

- 1) Make sure to understand the instructions of the power seeder before its use.
- 2) The power seeder should be used only for sowing rice seeds. (for wet fields)  
**If using in a dry field, it can lead to a failure of the machine.**
- 3) Make sure to stop the PTO and engine of the seeder before checking the power seeder during its use.
- 4) Make sure to check the joints, which connect the vehicle body and seeder section, for proper condition before operation. **Before operation, set the hydraulic lock lever in the neutral (stopping) position and run the engine at a low speed to check for any abnormal noise. Also, check that seeds and fertilizer are smoothly discharged. Finally, check the joints for any malfunction.**
- 5) Check the seed pressers for any foreign materials. Make sure that they are neatly maintained.  
**If there are foreign materials in them, seeds in them can be lost.**
- 6) Before work, check the engagement section of the seeder for proper engagement and disengagement operation.
- 7) Use only carefully selected seeds in a good condition for seeding.
- 8) After using the seeder, make sure to clean each outlet and discharging section thoroughly.
- 9) Adjust the seeding interval of the seeder from the seeder.
- 10) Make sure that all of 8 rows of the seed quantity adjusting plates are in the same position. (p. 23)
- 11) Avoid seeding in rainy conditions. **If water is on the outlets of the seeder, seeds may stick to the outlets, leading to unsown rows.**

# CHAPTER 3: PRECAUTION FOR SEEDER

## 2. Precautions before and after operation

- 1) Make sure that there are no foreign materials in each outlet and discharging section.
- 2) Check the power transferring section of the synchronizer for wear condition. Also, apply grease onto the joint and sliding section of the square pipe as necessary before work. **Make sure to apply grease onto each rotating part (joints, shafts, etc.) before and after operation in order to prevent their corrosion and damage.**
- 3) Operate the left and right marking rulers to check for their proper operation before work. **The wires can stretch and contract depending on the operating environment.**
- 4) Adjust the height of the float according to the field condition to ensure proper operation in the field.
- 5) When using the soil overflow protection plate near a bank in the field, lock the seeder in the lifted position to prevent its damage.
- 6) For the seeder equipped with the marking rulers, make sure to fold them inside and lock them securely before driving on a road to avoid an accident due to its interference with other objects.

## 3. Precautions for use

- Operate the marker control lever to the left and right to operate the soil overflow protection plate and marking rulers



### 3-1. Soil overflow protection plate

- This device is to minimize the amount of oil in the seeder pushed out of the seeder when seeding in a paddy field.

#### **CAUTION**

- Before seeding, unfold the soil overflow protection plates to use them. Also, when seeding near a bank in the field, fold them as shown in the figure to prevent their damage.



**Not in use  
(Working near a bank)**

# CHAPTER 3: PRECAUTION FOR SEEDER

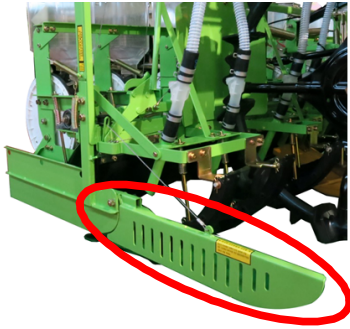

In use  
(Linked operation  
with left / right  
marking rulers)

## CAUTION

- Use the soil overflow protection plates only without the marking ruler under the following conditions :
  - If the left and right end rows are already sown
  - If either one of the left and right end rows is already sown and the other end is near an obstacle (bank, rock, etc.)

Remove the wire from the position shown in the picture below to deactivate the linked operation of the soil overflow protection plate and marking ruler.



### 3-2. Usage of marking ruler

- This device is to mark a center guide line on the ground for the next operation during seeding in a field.

- Adjusting marking ruler length
  - Unscrew its nut with a M17 spanner to adjust the length.

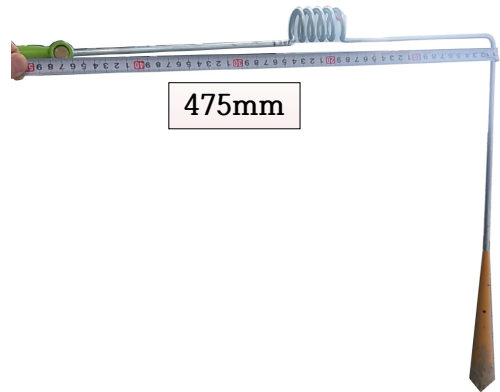

## CAUTION

- Disengage the spring hook as shown in the figure to use the marking ruler. Set it outward only during seeding operation.
- For storage, driving and transportation of the vehicle, set them inwards to avoid interference with any obstacles on the road.

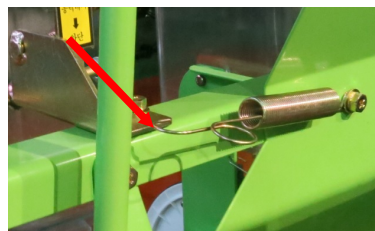

In operation



For storage and transportation



# CHAPTER 3: PRECAUTION FOR SEEDER

## 4. Operating float

- The float is designed to keep the seeder at a constant level on the field by transferring the change of its floating level to the motor section of the seeder.

### ■ Operation

- It lifts the seeder when there is an excessive amount of water or straws in the field.  
→ To minimize excessive accumulation of water or straws.
- It lowers the seeder when the soil is dry.  
→ To ensure even and consistent operation.

### ■ Adjusting float adjusting wire

- Tighten the wire bolt (shorter wire control section) for shallower seeding depth. Loosen the wire bolt to press the ground stronger for deeper seeding depth.

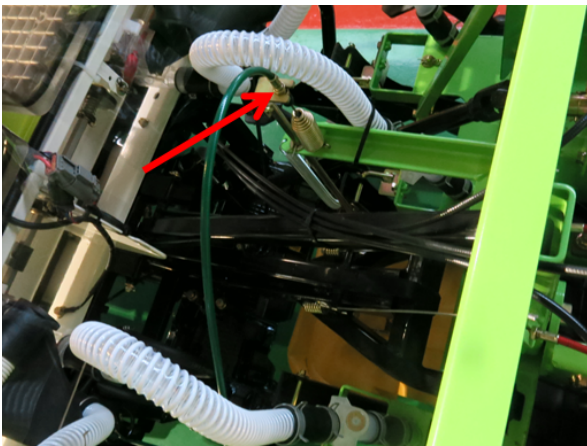

## 5. Operating pressing plate

- Move the seed pressing control lever up and down to control 8 seed pressing plates.

- The pressing plates are used to press discharged seeds onto the ground gently for better adhesion during seeding. They promote better moisture absorption and germination rate.



- When the pressing plates are not to be used, place the lever in the uppermost position.

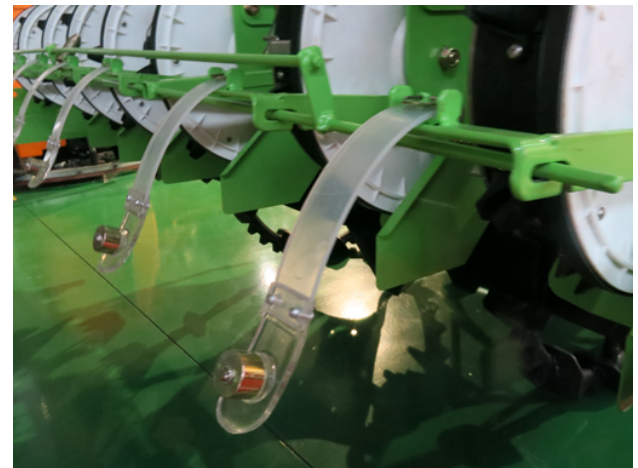

- To use the pressing plates, place the lever in the downmost position.

### ⚠ CAUTION

- However, avoid using them in a field with an excessive amount of water or mud. Using them can cause uneven seed distribution and excessively deep seeding, resulting in lower germination rate.



# CHAPTER 3: PRECAUTION FOR SEEDER

## 6. Adjusting seeding interval

- Use the seeding amount shift lever under the floor mat to adjust the seeding amount. As the seeding amount should be adapted to the ground condition, try the desired setting for 4-5 m and make any necessary adjustment.

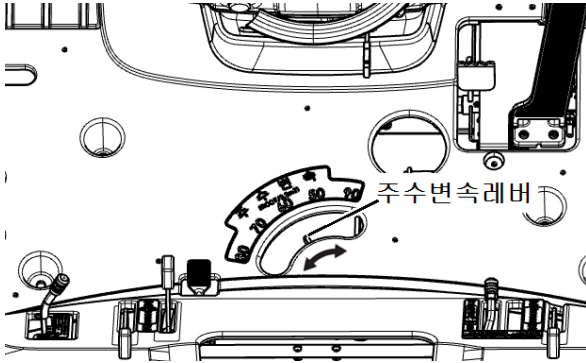

### [ Note ]

- The seeding amount changes according to the ground condition. Make adjustment considering the seeding condition.
- The seeding amount can be adjusted in 5 steps.

### <Shifting seeding amount>

- Set the main shift lever in the Neutral position and the seeding control lever in the Neutral position.
- Start the engine.
- Place the accelerator lever to the low speed position.
- Depress the shift pedal gently and set the speed lock lever to the Lock position.
- Move the seeding amount control lever under this condition for make adjustment as necessary.
- Stop the engine.

### Seeding amount table

Seeding amount shift	50	60	70	80	90
Number of seeds (seed/3.3m <sup>2</sup> )	50	60	70	80	90
Seeding interval (cm)	23	19	17	15	13

## 7. Adjusting hydraulic sensitivity

Adjust the automatic hydraulic pressure control sensitivity with the hydraulic sensitivity control lever according to the soil condition (hard/soft) so that the float is seated onto the ground properly.

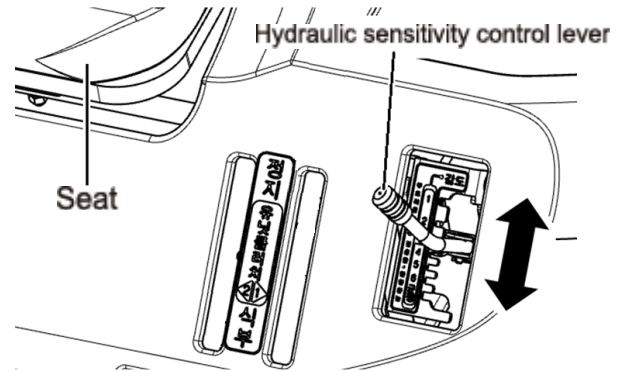

### Adjustment standard

Soil Condition	Lever Position
Soft soil (float presses soil)	Sensitivity, 1~2
Factory setting	3
Hard soil (float's soil leveling performance is poor or it rises off ground)	4~6
Rough field surface due to tire marks near bank	Harrowing

### [ IMPORTANT ]

- Set the hydraulic sensitivity control lever toward the position marked as soft soil to make the seeding depth shallower. Set it toward the position marked as hard soil/deep water to make the seeding depth deeper.

# CHAPTER 3: PRECAUTION FOR SEEDER

## 8. Adjusting seed dispenser

- Remove the side cover of the seed dispenser to adjust the discharging amount of seeds with the disc.

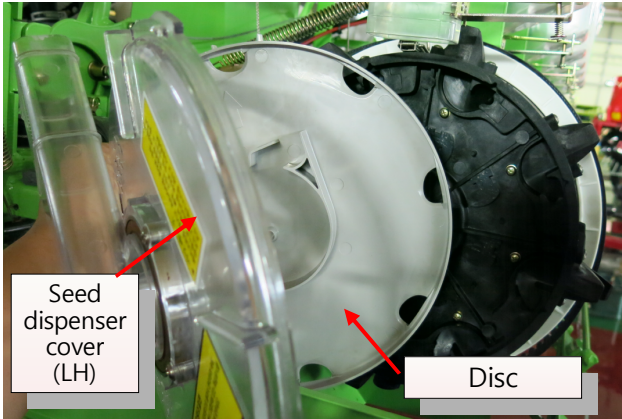

- Adjust the discharging amount of seeds by selecting the desired number (1 - 8) stamped on the circumference of the disc block in the middle of the dispenser shown in the picture below. Align the arrow mark on the disc with the desired number.

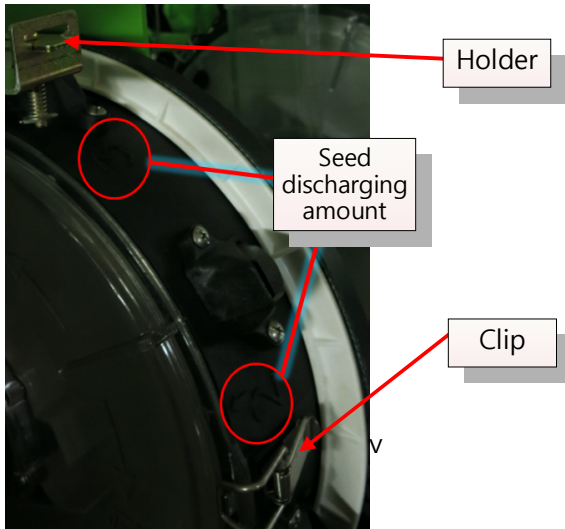

[Note] Size of outlet for different disc position



<Outlet for 1x>



<Outlet for 8x>

- Adjusting seed discharging amount with disc

- Empty the seed hopper or lock the seed guide tube holder.
- Undo the clip and turn the seed dispenser cover (LH) counterclockwise to remove it.
- Pull out the disc and install it onto the desired position.
  - Make sure to remove any foreign materials from the mounting surface as any remaining seeds can affect the mounting condition.
- Assemble in the reverse order of disassembly.

### CAUTION

- Make sure to adjust all of 8 dispensers to the same number. (To ensure even seeding)

- How to check for correct disc installation



- Disengage the PTO clutch and try rotating the seeder.
- The condition of the installation position can be checked from the side. (Checking the mounting groove of the disc)

- Discharging remaining seeds

- Lift the seeder and set the hydraulic lock control lever into the Lock position.

# CHAPTER 3: PRECAUTION FOR SEEDER

---

- ② Lock the seed guide tube holder.
- ③ Place containers or big cloth under the seeder to collect discharged seeds.
- ④ Undo the clip and turn the seed dispenser cover (LH) counterclockwise to remove it.
- ⑤ Collect any falling seeds while performing the step 4.
- ⑥ Remove the seed dispenser cover (LH) and open the seed guide tube holder to discharge all seeds from the dispenser.
- ⑦ Assemble in the reverse order of disassembly.

## 9. Precautions for using seeds with pesticides

- Never use an undiluted solution of dimecron, endosulfan or DDVP.

### CAUTION

- If using an undiluted pesticide solution, it may have a chemical reaction with the dispenser material, resulting in cracks or breakage of the dispenser.
- If it is needed, make sure to dilute it with water.

## 10. Precautions for seeds

- 1) Remove straws and branches of seeds before sowing them.
- 2) Bud the eye of seeds for less than 2 mm before sowing them.
- 3) Dry seeds in shade to remove any moisture.
- 4) Make sure to dry the seeder completely before using it after washing it with water.
- 5) Open the covers of the dispensers to keep them dry while seeding.

# CHAPTER 4: PRECAUTION FOR FERTILIZER APPLICATOR (OPTION)

## 1. Preparation before operation

### ■ Vehicle transportation

- When transporting the vehicle by loading it onto a transporting truck, make sure that the float section's furrow opener is not damaged. Also, fix the side manuring machine frame with ropes to prevent its deformation.

### ▲ CAUTION

- Tighten the cover of the hopper firmly so that it is not loosened and damaged.

### ■ Preparation for fertilizer

- Keep the inside of the fertilizer hopper out of foreign materials and moisture.
- Make sure that fertilizer lump is not formed in the hopper and fertilizer is not tangled onto the roller.
- Fertilizer can absorb moisture. Do not pour fertilizer lumps into the hopper.

### ▲ CAUTION

- If there is some fertilizer left in the hopper after operation, empty the hopper and keep moisture away from the hopper. If fertilizer is left in the manuring machine, it can be hardened and lead to malfunction.

### ■ Prior inspection and adjustment of fertilizer amount

: Do not load seedlings onto the tray.

- ① To check the fertilizer amount before operation, lift the transplantation unit 30 - 40 cm off the ground and lock the hydraulic pressure.
- ② Place containers to collect fertilizer under the furrow openers of the grippers. (Use tall containers.)
- ③ Rotate the rotor case for 100 or 200 turns without seedlings on the tray.

- ④ Measure the weight of collected fertilizer and compare it with the planned amount.
- ⑤ Adjust the fertilizer amount with the adjuster according to the quick reference.

### ▲ CAUTION

- The proper fertilizer amount is varied by types of fertilizers. Check the corresponding proper amount in advance before operation.

## 2. Correct operation and precautions during operation

### 2-1. Operation

- Make sure that the amount of fertilizer in the hopper is sufficient.
- Set the main shift lever (switch) in the "Engage" position.
- Check that the blower operates.
- While starting off at a low speed, check that the side manuring machine operates.

### 2-2. Precautions during operation

- Keep the following instructions to ensure proper manuring.

## CHAPTER 4: PRECAUTION FOR FERTILIZER APPLICATOR (OPTION)

- If stopping the vehicle during transplanting seedlings, remaining fertilizer in the hose may be spread to one spot (excessive amount). Do not stop during transplanting.
- When adding fertilizer to the hopper, avoid doing it in the middle of a field. Do it at the side of the field.
- If stopping the seeder abruptly, the excessive amount of fertilizer may be discharged. Start and stop the seeder at a low speed.
- Before turning, lift the transplantation unit.
- Check that the furrow opener discharges fertilizer properly and the roller case operates properly during operation.
- When stopping the seeder in the middle of a field, lift the seeder and lock the seeder from falling down.
  - If the furrow opener's bellows pipe, which is attached to the float, is clogged by mud, it cannot spread fertilizer properly.
- Do not touch the PTO section during operation.

### 3. Maintenance after operation

#### 3-1. Inspection after operation

- Place a fertilizer sack under the fertilizer discharge hose and open the outlet to discharge fertilizer completely from the hopper.
- To discharge fertilizer from the fertilizer delivery case or roller grooves, operate the manuring machine. Otherwise, disassemble the fertilizer delivery case to remove fertilizer.

#### CAUTION

- If fertilizer is left in the hopper after operation, it absorbs moisture and becomes hard, leading to abnormal operation of the fertilizer delivery case and damage of the side manuring machine.

#### 3-2. Storage after operation

- Keep the following instructions to ensure proper fertilizer distribution.

- If checking or servicing the side manuring machine with the engine running, it can lead to an accident. Make sure to stop the engine before checking or servicing the distributor.
- If the side manuring machine is rinsed with water, dry it completely.
- Fertilizer can damage metallic parts and other parts easily. Make sure to clean each part thoroughly.
- To store the side manuring machine for the power seeder, lower the side bumper so that the furrow opener and soil covering plate, which is attached to the float, are not damaged.

# CHAPTER 5: TROUBLE SHOOTING

## 1. Troubleshooting

### 1-1. Seeds or fertilizer is not discharged.

Cause	Action
① The ground PTO of the motor section does not run.	<ul style="list-style-type: none"> <li>● Check the position of the interval control lever and gear engagement of the motor section.</li> <li>● Check the PTO section condition.</li> </ul>
② The ground PTO runs but the drive shaft of the seeder does not rotate.	<ul style="list-style-type: none"> <li>● Check if the driveline of the seeder rotates.</li> </ul>
③ The drive shaft of the seeder rotates but seeds (fertilizer) are not discharged.	<ul style="list-style-type: none"> <li>● Check the discharging system (dispenser) for fertilizer/seeds for a proper condition.</li> </ul>
④ The discharging system operates, but fertilizer/seeds are not discharged.	<ul style="list-style-type: none"> <li>● Check the outlet or connection to the connecting tube.</li> <li>● Too much moisture in seeds creates lumps, leading to poor discharging performance. Dry seeds properly before sowing them.</li> </ul>
⑤ The blower does not operate (for manuring machine).	<ul style="list-style-type: none"> <li>● Check the blower components (wirings, limit switch, etc.).</li> </ul>

### 1-2. An abnormal amount of seeds is sown.

Cause	Action
① The sowing amount is different by rows.	<ul style="list-style-type: none"> <li>● Check that all seed quantity adjusting discs are in the same position.</li> </ul>
② The discharging amount of seeds is insufficient or excessive.	<ul style="list-style-type: none"> <li>● Select a higher number to increase the quantity and a lower number to decrease the quantity of discharging seeds.</li> </ul>

### 1-3. The seeder pushes out oil.

Cause	Action
① The float is buried under soil.	<ul style="list-style-type: none"> <li>● Check if that operating angle of the float is same to the factory setting.</li> </ul>
② The float operates properly above soil.	<ul style="list-style-type: none"> <li>● Adjust the sensitivity control lever to increase the sensitivity.</li> </ul>

### 1-4. The marking ruler operates abnormally.

Cause	Action
① The marking ruler cannot be lowered by operating the marker control lever.	<ul style="list-style-type: none"> <li>● Check the operation detecting section of the control lever or the operating section of the actuator.</li> </ul>
② The marking ruler can be lowered, but it is lifted as soon as the motor section is slinked over the limit.	<ul style="list-style-type: none"> <li>● Check the assembly condition of the marker wire between the seeder and motor section.                             <ul style="list-style-type: none"> <li>→ Adjust the wire so that the marking ruler is almost parallel to the ground when operating it with the seeder off the ground for approximately 30cm.</li> </ul> </li> </ul>

# CHAPTER 5: TROUBLE SHOOTING

---

## 1-5. The seed pressing system abnormally operates.

Cause	Action
① The lever operates, but the pressing system does not operate.	● Check the condition of the connecting wire.
② The lever is heavier than usual.	● Check the operating link and spring system.

## 1-6. Distributed fertilizer is not covered with soil properly (for manuring machine).

Cause	Action
① There are a lot of straw or grass in the field.	● Remove straw and grass from the field as much as possible.
② The soil covering plate is distorted or loose.	● Install the soil covering plate properly.
③ The field soil is too hard or lack of water.	● Adjust the angle of the soil covering plate. ● Adjust the sensitivity.

## 1-7. The fertilizer distribution roller rotates, but the amount of fertilizer distributed is different among the grippers (for manuring machine).

Cause	Action
① The blower operation is different from the factory setting (for manuring machine).	● Check the blower components (wirings, limit switch, etc.).
② There are wet fertilizer lumps stuck on the fertilizer distribution roller.	● Remove the delivery case to clean it.
③ Delivered fertilizer is wet.	● Remove wet fertilizer and fill the hopper with new dry fertilizer.
④ The control lever is in the Disengage position.	● Set the lever in the Engage position.

# CHAPTER 6: APPENDIX

## 1. Major specifications

Model number			<b>ARP-8S(F)</b>	
Dimensions	Overall length	(mm)	3,050	
	Overall width for storage	(mm)	2,330	
	Overall height	(mm)	1,620	
	Min. ground clearance	(mm)	350	
Weight			(kg) 850 (including seeder and manuring machine)	
Engine	Type		GX630	
	Type		Air-cooled 4-cycle 2-cylinder OHV gasoline engine	
	Total displacement	(cc)	688	
	Power/Revolutions (max.)	(kW{PS}/rpm)	12{14.8}/3,600	
	Applicable fuel		Unleaded gasoline for automobiles	
	Fuel tank capacity	(ℓ)	23	
Dimensions	Steering type		Center yoke (power steering)	
	Wheel	Type x quantity	Front wheel	Airless tire x 2
			Rear wheel	Rubber rug tire x 2
		Outer diameter (mm)	Front wheel	650
			Rear wheel	900
	Gears		(단) 2 front gears & 1 reverse gear x HST continuous shift	
Implementation	Applicable seeds		Rice seed	
	Dimensions		Seeder	Side manuring machine
	Length		830	420
	Width (mm)		2380	2140
	Height (mm)		800	570
	Weight (kg)		180	73
	Number of rows		8	
	Seed hopper capacity (kg)		5 kg x 8 = 40 kg	
	Fertilizer hopper capacity (kg)		20 kg x 4 = 80 kg	
	Discharging amount control type		Slider roller groove	
	Discharging roller operation		Belt transfer type by seeder drive shaft	
	Interval (mm)		250 , 360	
	Sowing width (mm)		1970	
	Applicable seeder		Ride on type seeder (over 12 hp)	
Sowing type		Drill seeding/hill seeding		
ERTILIZER APPLICATOR		Option		
Warning system			<ul style="list-style-type: none"> <li>● Fuel gauge</li> <li>● Reverse alarm buzzer</li> <li>● Fertilizer delivery/fertilizer clogging warning lamp and buzzer</li> </ul>	

※ This specification information is subject to change without notice for quality improvement.



# CHAPTER 6: APPENDIX

## 2. Major supplies and replacements (for vehicle body)

No	Part name	Part number	No	Part name	Part number
			10	Hydraulic hose and pipe	-
			11	Electric wiring	-
3	Longitudinal conveying shaft bushing	RP010-E9031	12	Battery	RP010-32011
			13	Spark plug	RP010-01181
5	V-belt SB27HP-X (Engine)	RP010-41131	14	Fuel strainer	RP010-08071
	V-belt(LA-32.25) (Cleaning pump)	RP010-J1011	15	Fuel filter	RP010-21081
6	Wire	-			
7	Fuel hose	-			
8	Transmission fluid filter	RP010-30011			
9	Engine oil filter	RP010-03061			

3. Longitudinal conveying shaft bushing

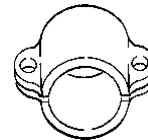

5. V-belt



6. Wire

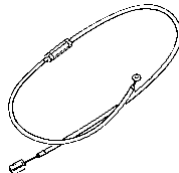

7. Fuel hose

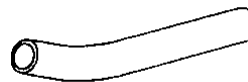

8. Transmission fluid filter

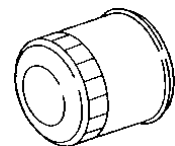

9. Engine oil filter

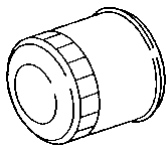

10. Hydraulic hose and pipe



11. Electric wiring



12. Battery

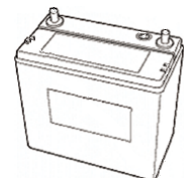

13. Spark plug

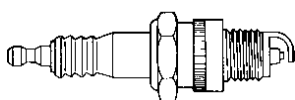

14. Fuel Straine

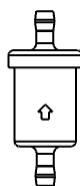

15. Fuel filter

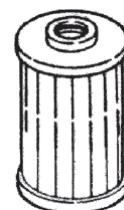

# CHAPTER 6: APPENDIX

---

## 3. Seeder exterior

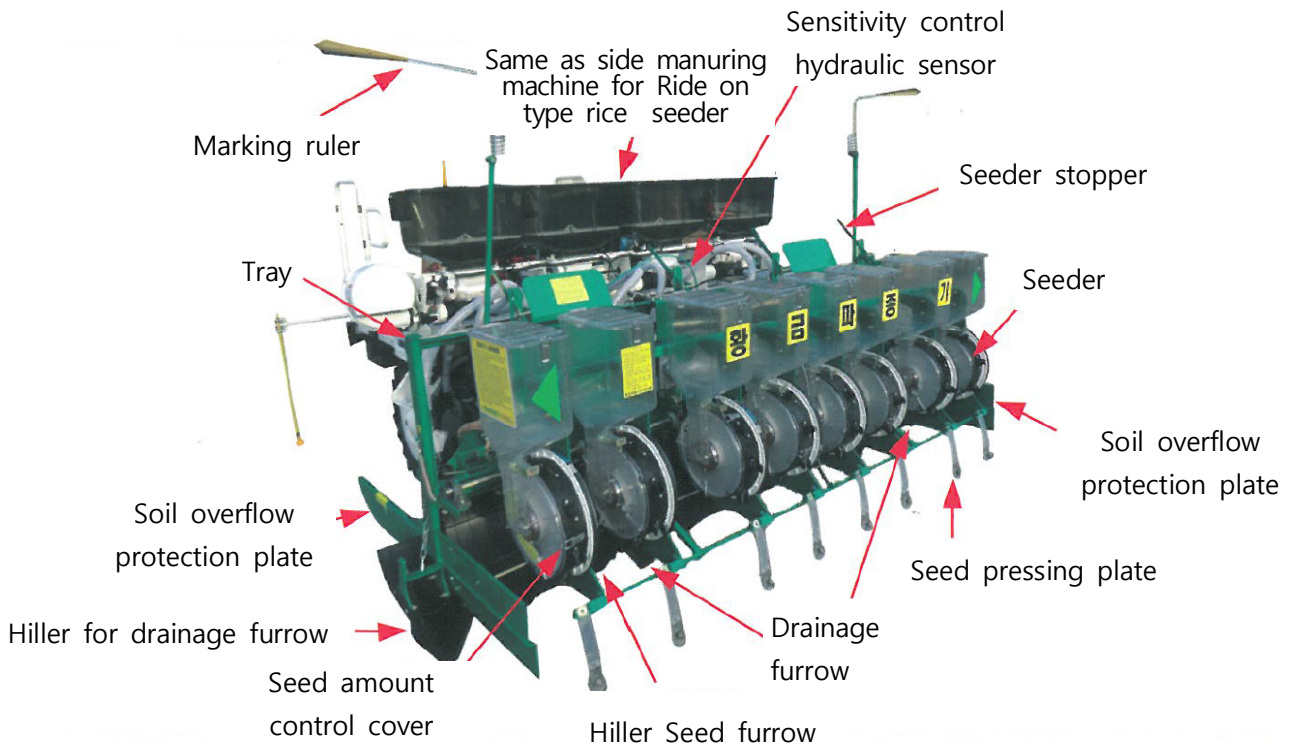

# CHAPTER 6: APPENDIX

## 4. Manuring machine exterior

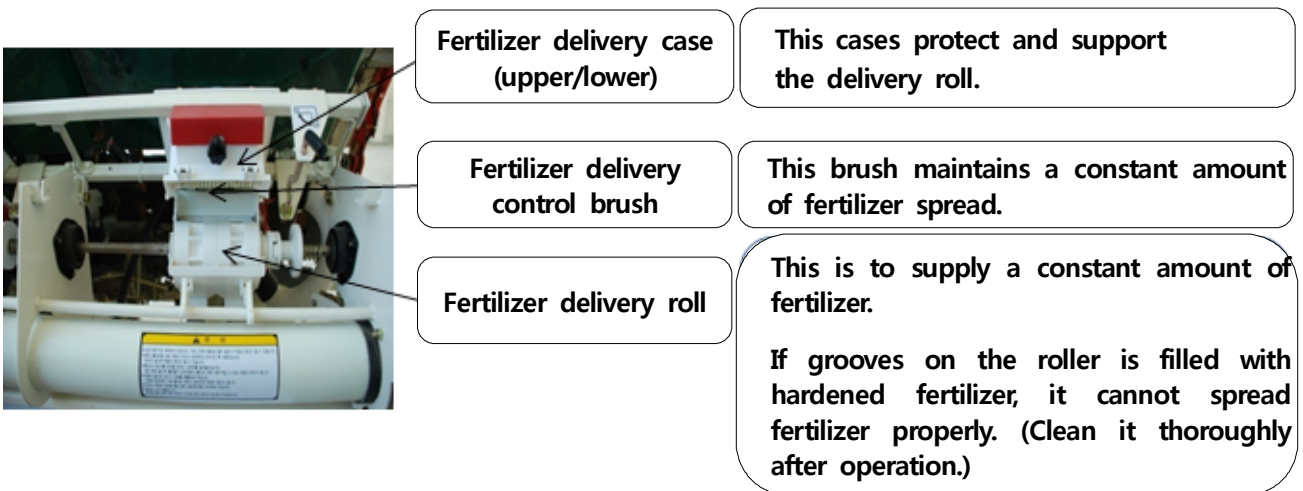
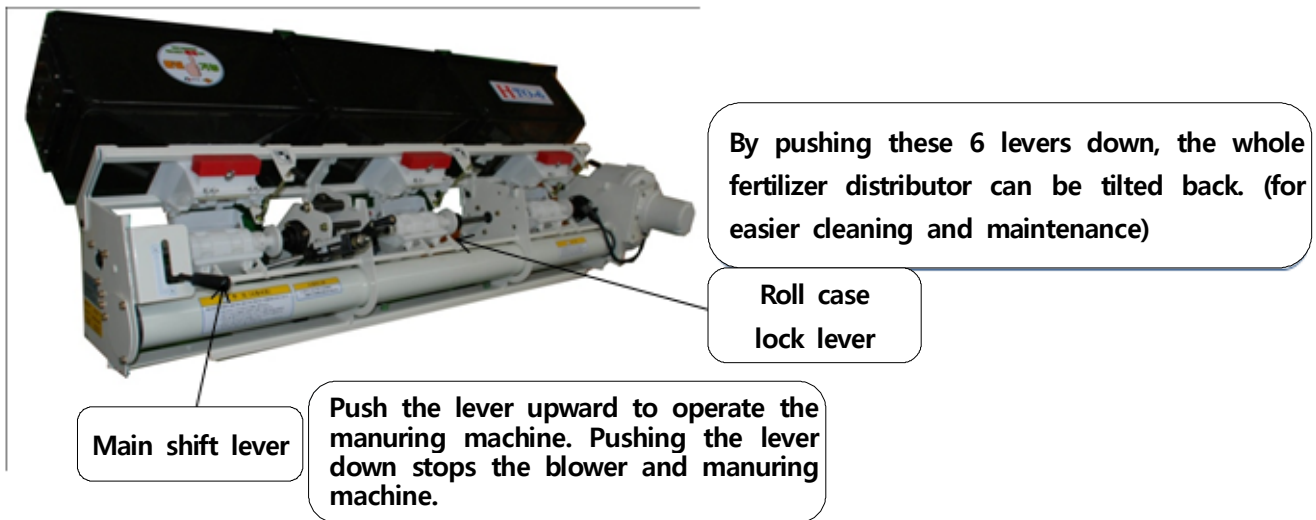
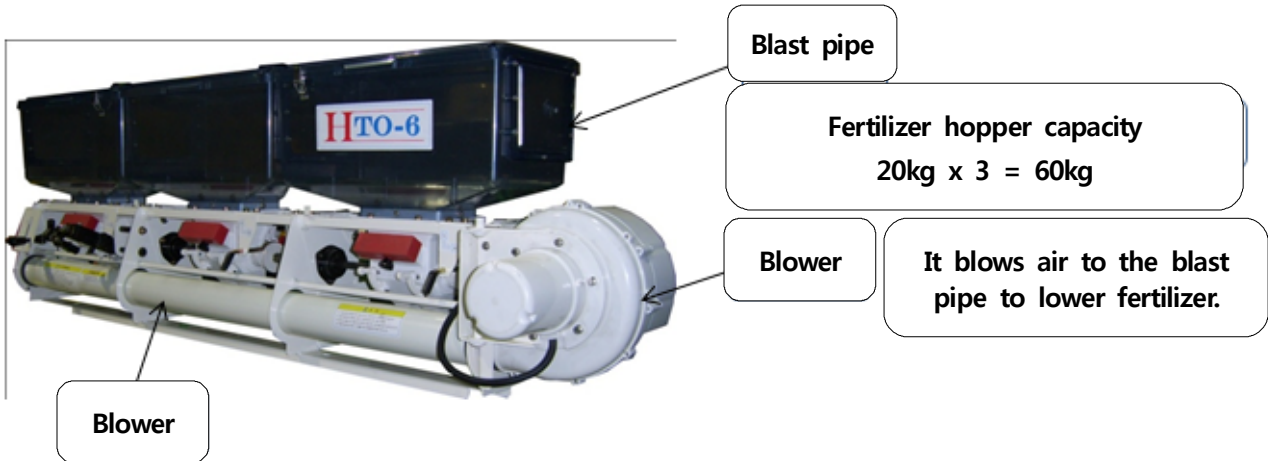

# CHAPTER 6: APPENDIX

## 4. Manuring machine exterior



Fertilizer amount control lever

It is used to adjust the fertilizer amount.  
[CAUTION]  
Refer to the quick reference on the top of the fertilizer hopper for adjustment.



Gear case

To discharge only a small amount of fertilizer (12 kg/1000 m<sup>2</sup> or less), move and install it to the small fertilizer amount hole. (only for certain models)



Discharge hose

It is used to discharge any left fertilizer.  
[CAUTION]  
After operation, remove fertilizer from the hopper and delivery case.

Fertilizer hose

It is used to supply fertilizer.  
[CAUTION]  
If the hose is twisted or deformed, it can lead to restriction by fertilizer.

# CHAPTER 6: APPENDIX

## 5. Engine exterior

